

REINFORCEMENTS



Glass Reinforced Concrete. The Strength of Concrete. The Convenience of Plastic.

45-51 Clapham Road, Regents Park NSW 2143

Ph: (02) 9644 1044



You can cut GRC risers on site

Adjustable risers? No problem!

We understand that things don't always go to plan. Have you ever needed an odd size riser - something like 138mm, or 424mm?

With our exclusive Glass Reinforced Concrete Risers, anything is possible.

The qualities of GRC enable you to cut down your riser to the height you need on site.

Our 175mm risers are straight edged, so that when you cut them down, they will still fit straight into the rebate of your pit.

This is just another reason why you should choose GRC pits for your next project. If you have any questions, contact our Sales Team on (02) 9644 1044.



New Solid Top Cast Iron Covers

These covers are designed to fit into the rebate of our GRC Pits and suit up to a Class C rating.

There'll be more news about these exciting new covers in the next issue of our newsletter.

Welcome

Welcome to our second issue for 2007 and our thanks to all those who told us how much they enjoyed our previous newsletter.

One of the most important reasons for producing this publication is to keep you informed of developments in the world of Glass Reinforced Concrete.

Since we've been making GRC products for over 25 years we can proudly claim to be Australia's leading manufacturer in this remarkable material.

In this issue we give you some tips on just how easy it is to work with GRC. GRC pits don't have knockouts. You choose where the entries go and what size they'll be.

We also show you how easy it is to get an odd size riser thanks to the user-friendly qualities of GRC.

Every now and then someone comes out with 'budget' versions of GRC-type products that claim to be "the same as Mascot's" but naturally have a cheaper price.

Their lighter weight is a giveaway. The walls are thinner and the materials are definitely not up to Mascot's standards.

It's not that we mind some genuine competition, but tests quickly show just how inferior these low-end products really are.

Why trust your reputation to unbranded 'me too' products?

Mascot Engineering products have the approval of authorities like Sydney Water, local councils and Government departments.

When you're selling or using products with the big red 'M' you know you're selling something that's going to meet the needs of your customers for years to come.

Nick Taylor.

Watertight/Gastight Access Covers that really blend in



Our extensive range of watertight and gas-tight access covers include covers with brass, stainless steel and aluminium edges for tiling, carpeting or paving.

These covers are available in any size and load rating, with a standard floor finish depth of 18mm.

We can also manufacture covers with an edge strip height to your specifications if required.

The keyhole is the same height as the edge strip, and a keyhole cover in the same material as the edge strip is provided. Bolt down systems and security systems are available.

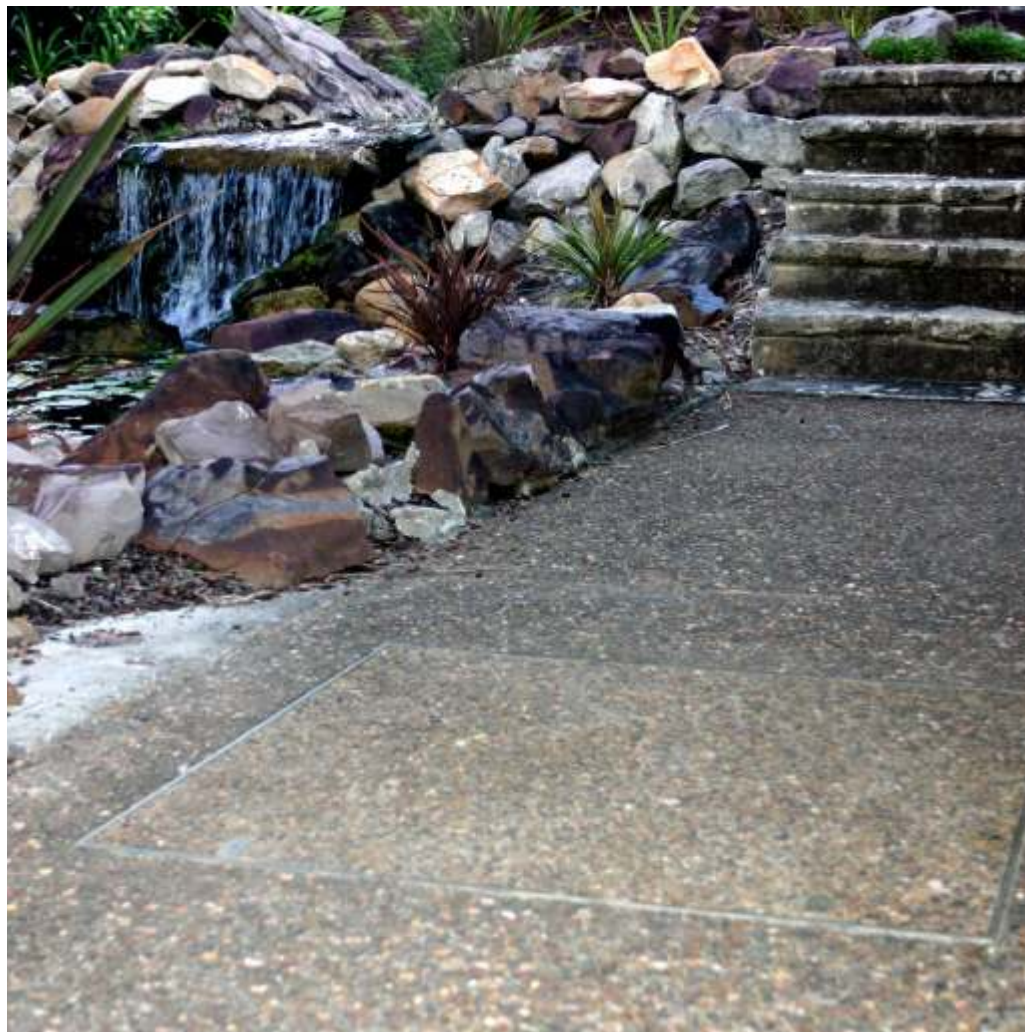
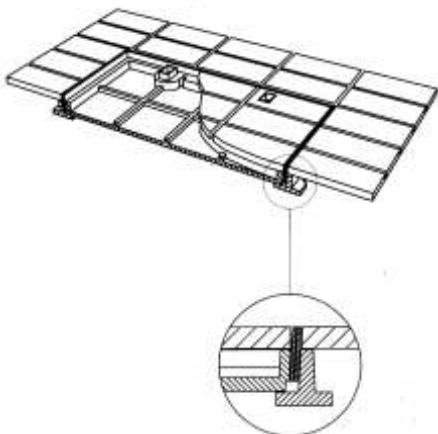

Conduit entries have never been so easy

GR Concrete pits don't have a knockout, leaving you to choose where the entries are to go as well as the size and number of entries on each side.

There's no need to 'stitch' drill. Simply mark out where the entry is to be made and starting in the centre, softly tap the pit with a ball pein hammer.

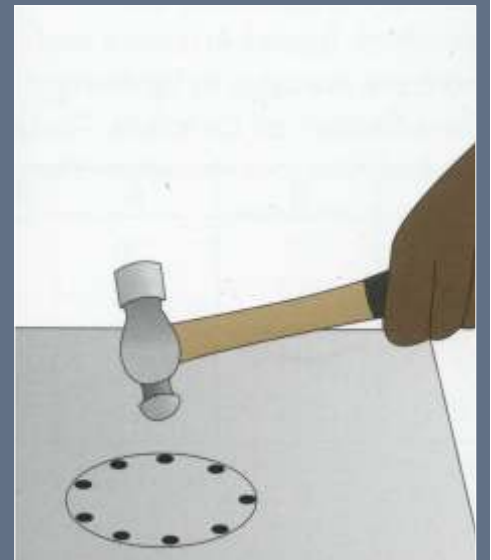
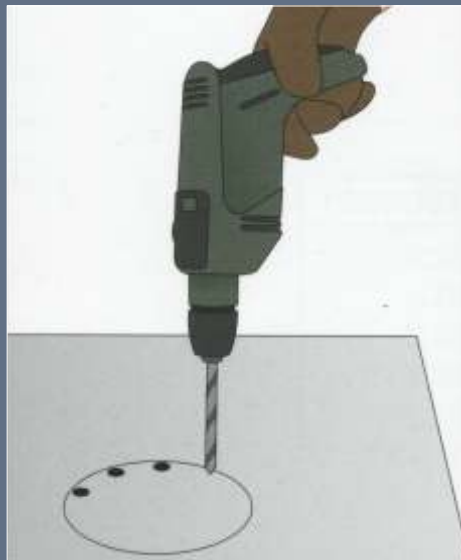
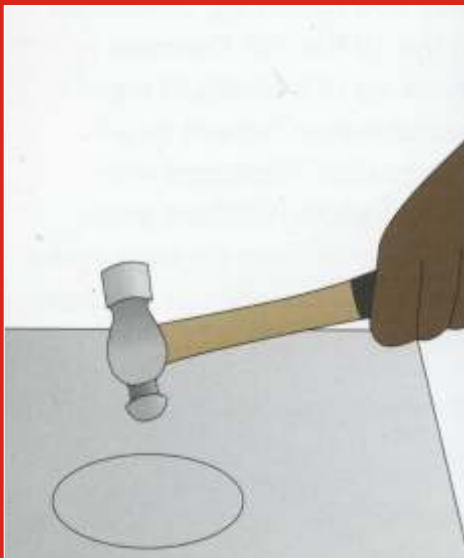

Alternatively, for larger entries (150mm), once you've marked out the hole required, use a masonry drill to drill at 50mm centres. Holes can also be formed using a grinder with masonry disc.

Bollards part of Sydney's history



As the black & white photo taken in Sydney's Rocks area in the 1970s shows, Mascot Engineering footpath bollards are a part of Sydney's history, and the bollards lining Art Gallery Road in this recent photo look just as good now as they did when new.



We'll host your next barbie!



Everyone likes a barbeque. They're a great way to entertain your customers and to get to know them better.

Throughout the year we host barbeques for our resellers at their premises.

They invite their customers and we provide the chef who cooks the eggs and bacon for them.

ORDERS FILLED - NO DELAY

Our large stockholding means that most products are in stock at all times, so call us first and get just what you want when you want it!

(02) 9644 1044

Electrical Cable and Conduit Ducting

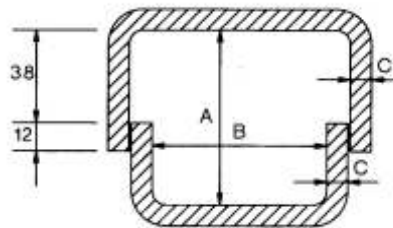
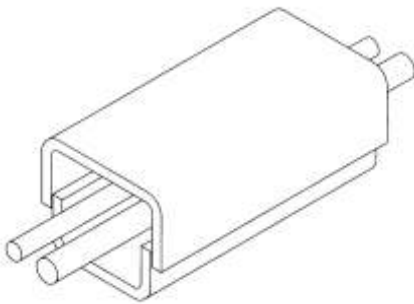

SAME DAY SERVICE

We can supply most products the same day you place your order. Ring us when you need something from our extensive range and we'll get it to you FAST!

(02) 9644 1044



MASCOT ENGINEERING GROUP

45-51 Clapham Road, Regents Park NSW 2143 Australia
Phone: (02) 9644 1044 Fax: (02) 9645 2927
Email: sales@mascoteng.com.au
Web: www.mascoteng.com.au